



Spec. No.	PS-ND-08090601
Rev.	A

# PRODUCT SPECIFICATION

**Model No: CSM-57171EG/57181EG**

## Descriptions:

- 1.2 Inch 5X7 Dot-Matrix Display
- Dot Pitch 4.57mm
- CSM-57171: Column Anode, Row Cathode
- CSM-57181: Column Cathode, Row Anode
- Emitting Color: Orange & Yellow Green



CUSTOMER APPROVED	APPROVED BY	CHECKED BY	PREPARED BY
SIGNATURES			

**CHINA SEMICONDUCTOR CORPORATION**  
Address:2FL. NO.909,Chung-Cheng Road,  
Chung-Ho City Taipei Hsien,Taiwan.

Tel:886-2-2223-9696  
Fax:886-2-2223-9377

**OPTO PLUS TECHNOLOGIES CO.,LTD**  
Address:696 Shun jiang Rd.,Ji Shan St.Shaoxing,  
ZheJiang,China

Tel:86-0575-88623888  
Fax:86-0575-88623112



Spec. No.	PS-ND-08090601
Rev.	A

**Model No: CSM-57171/57181EG**

■ **Features -**

1. 1.2 inch (30.3mm) Matrix height.
2. Case mold type.
3. RoHS compliant.
4. Low power consumption.
5. Easy mounting on P.C. board or socket.

■ **Device Selection Guide -**

Part No.	Chip		Description	
	Material	Emitted Color	Column	Row
CSM-57171EG	GaAsP	Orange	Anode	Cathode
	GaP	Yellow Green		
CSM-57181EG	GaAsP	Orange	Cathode	Anode
	GaP	Yellow Green		

■ **Package Dimensions -**

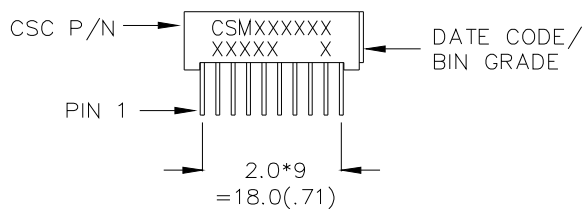
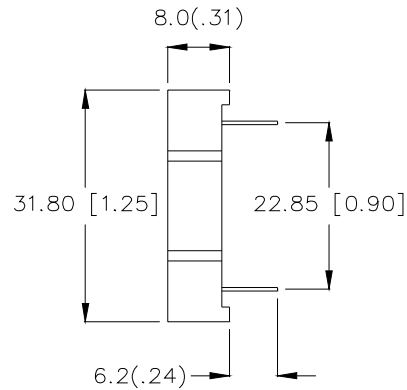
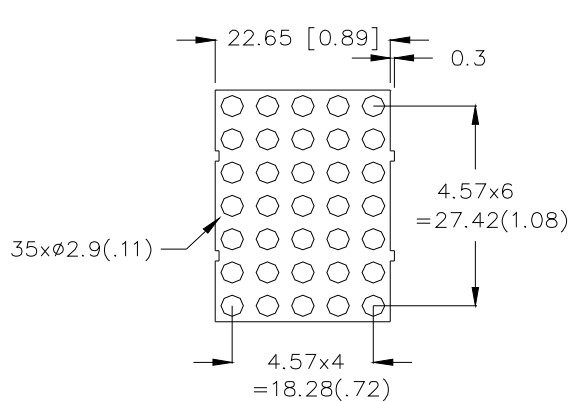

**NOTE:**

- 1 All pins are ø0.5(.02).
- 2 Dimension in millimeters (inch), tolerance is ±0.25 (.01) unless otherwise noted.



Model No: CSM-57171/57181EG

Internal Circuit Diagrams -

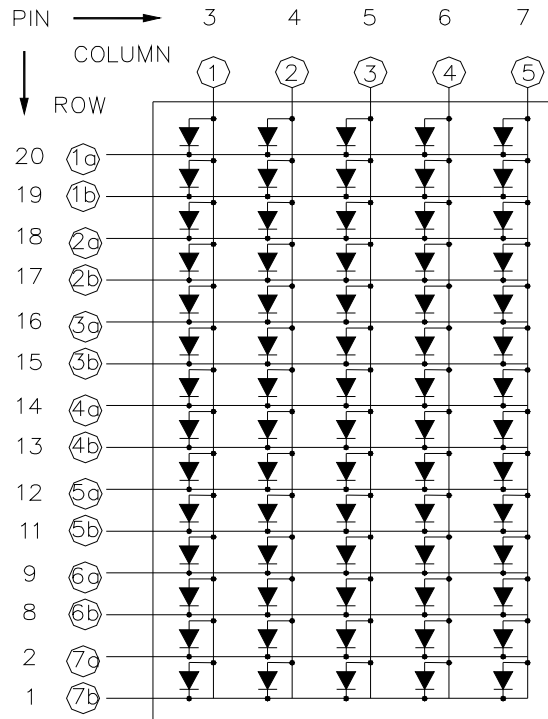

NOTE: "a" Orang color chip

"b" Yellow Green color chip

CSM-57171 Column Anode, Row Cathode.

(CSM-57181 Column Cathode, Row Anode.)

Absolute Maximum Rating -

Orange		(Ta=25°C)	
Parameter	Symbol	Rating	Unit
Power Dissipation Per Dice	PAD	75	mW
Continuous Forward Current Per Dice	IAF	25	mA
Peak Current Per Dice(duty cycle 1/10, 1kHz)	IPF	90	mA
Derating Linear From 25°C Per Dice	-	0.33	mA/°C
Reverse Voltage Per Dice	VR	5	V
Operating Temp.	Topr	-35 ~ +85	°C
Storage Temp.	Tstg	-35 ~ +85	°C
Solder temperature 1/16 inch below seating plane for 3 seconds at 260°C			



Model No: CSM-57171/57181EG

Yellow Green		(Ta=25°C)	
Parameter	Symbol	Rating	Unit
Power Dissipation Per Dice	P <sub>AD</sub>	75	mW
Continuous Forward Current Per Dice	I <sub>AF</sub>	25	mA
Peak Current Per Dice(duty cycle 1/10, 1kHz)	I <sub>PF</sub>	90	mA
Derating Linear From 25°C Per Dice	-	0.33	mA/°C
Reverse Voltage Per Dice	V <sub>R</sub>	5	V
Operating Temp.	T <sub>opr</sub>	-35 ~ +85	°C
Storage Temp.	T <sub>stg</sub>	-35 ~ +85	°C
Solder temperature 1/16 inch below seating plane for 3 seconds at 260°C			

■ Electro-optical Characteristics -

Orange		(Ta=25°C)				
Parameter	Symbol	Min.	Typ.	Max.	Unit	Condition
Forward Voltage Per Segment	V <sub>F</sub>	-	2.1	2.8	V	I <sub>F</sub> =20mA
Luminous Intensity Per Segment	I <sub>v</sub>	-	-	-	ucd	I <sub>F</sub> =10mA
Peak Emission Wavelength	λ <sub>p</sub>	-	632	-	nm	I <sub>F</sub> =20mA
Dominant Wavelength	λ <sub>d</sub>	-	624	-	nm	I <sub>F</sub> =20mA
Spectrum Radiation Bandwidth	Δλ	-	35	-	nm	I <sub>F</sub> =20mA
Reverse Current	I <sub>R</sub>	-	-	100	μA	V <sub>R</sub> =5V
Luminous Intensity Matching Ratio	I <sub>V-m</sub>	-	-	2:1		I <sub>p</sub> =80mA 1/16Duty

Yellow Green		(Ta=25°C)				
Parameter	Symbol	Min.	Typ.	Max.	Unit	Condition
Forward Voltage Per Segment	V <sub>F</sub>	-	2.1	2.8	V	I <sub>F</sub> =20mA
Luminous Intensity Per Segment	I <sub>v</sub>	-	-	-	ucd	I <sub>F</sub> =10mA
Peak Emission Wavelength	λ <sub>p</sub>	-	568	-	nm	I <sub>F</sub> =20mA
Dominant Wavelength	λ <sub>d</sub>	-	572	-	nm	I <sub>F</sub> =20mA
Spectrum Radiation Bandwidth	Δλ	-	30	-	nm	I <sub>F</sub> =20mA
Reverse Current	I <sub>R</sub>	-	-	100	μA	V <sub>R</sub> =5V
Luminous Intensity Matching Ratio	I <sub>V-m</sub>	-	-	2:1		I <sub>p</sub> =80mA 1/16Duty



Spec. No.	PS-ND-08090601
Rev.	A

Model No: CSM-57171/57181EG

■ Typical Electrical / Optical Characteristics Curves -Orange

(Ta = 25°C Unless Otherwise Noted)

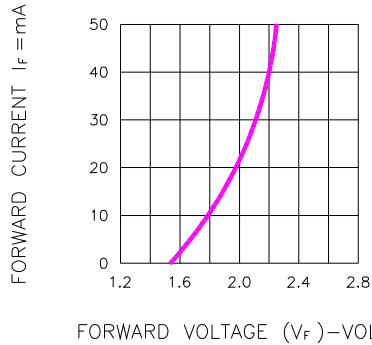

Fig.1 FORWARD CURRENT VS. FORWARD VOLTAGE

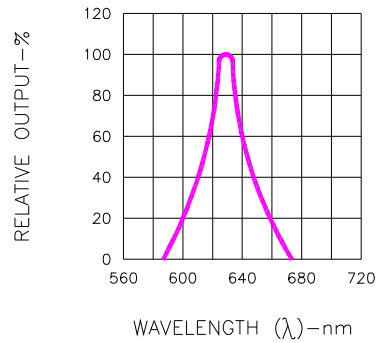

Fig.2 SPECTRAL RESPONSE

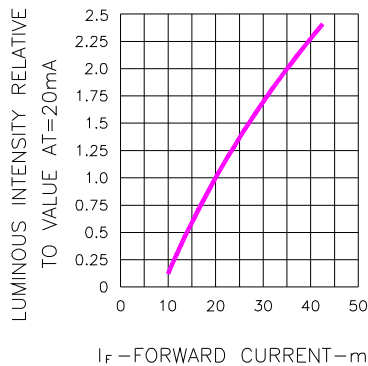

Fig.3 RELATIVE LUMINOUS INTENSITY VS. FORWARD CURRENT

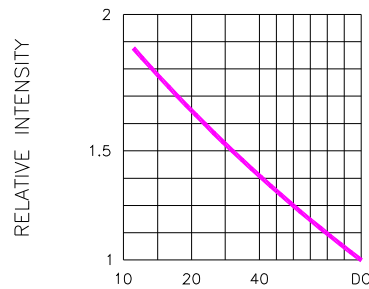

Fig.5 LUMINOUS INTENSITY VS. DUTY CYCLE

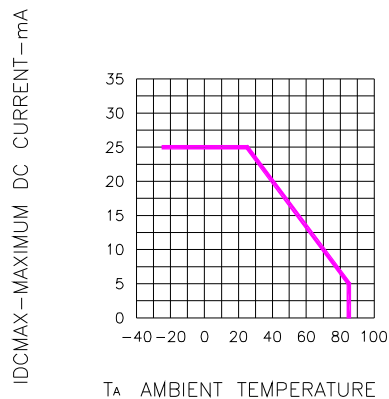

Fig.4 MAXIMUM ALLOWABLE DC CURRENT PER SEGMENT VS. A FUNCTION OF AMBIENT TEMPERATURE

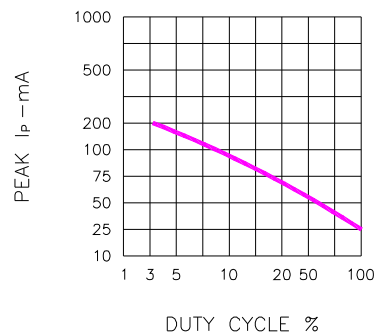

Fig.6 MAX PEAK CURRENT VS. DUTY CYCLE % (REFRESH RATE f=1 KHz)



Model No: CSM-57171/57181EG

■ Yellow Green

(Ta = 25°C Unless Otherwise Noted)

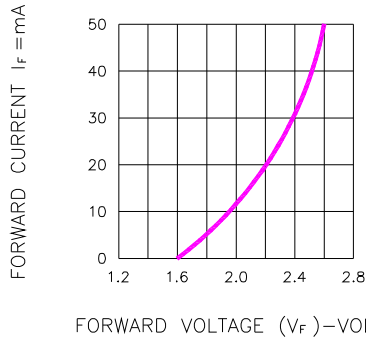

Fig.1 FORWARD CURRENT VS. FORWARD VOLTAGE

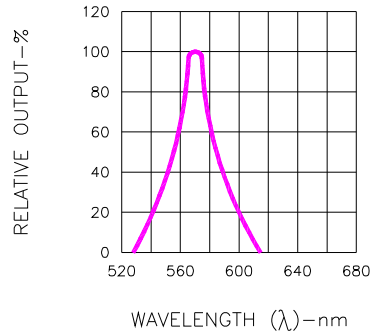

Fig.2 SPECTRAL RESPONSE

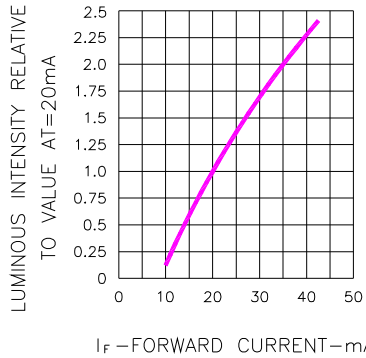

Fig.3 RELATIVE LUMINOUS INTENSITY VS. FORWARD CURRENT

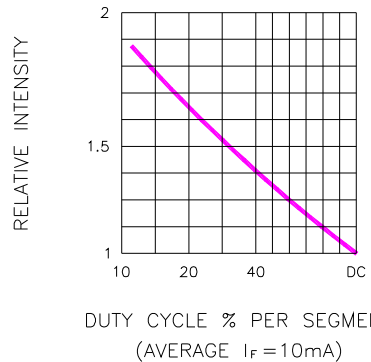

Fig.5 LUMINOUS INTENSITY VS. DUTY CYCLE

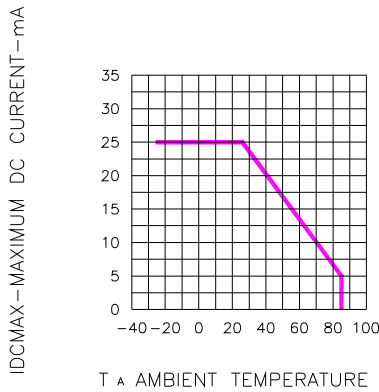

Fig.4 MAXIMUM ALLOWABLE DC CURRENT PER SEGMENT VS. A FUNCTION OF AMBIENT TEMPERATURE

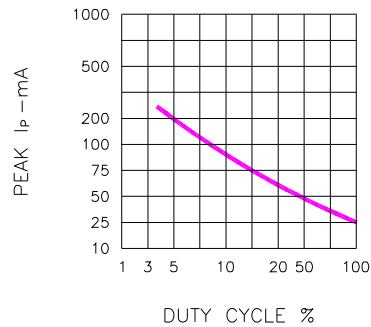

Fig.6 MAX PEAK CURRENT VS. DUTY CYCLE % (REFRESH RATE f=1 KHz)



Spec. No.	PS-ND-08090601
Rev.	A

Model No: CSM-57171/57181EG

■ Package Dimensions

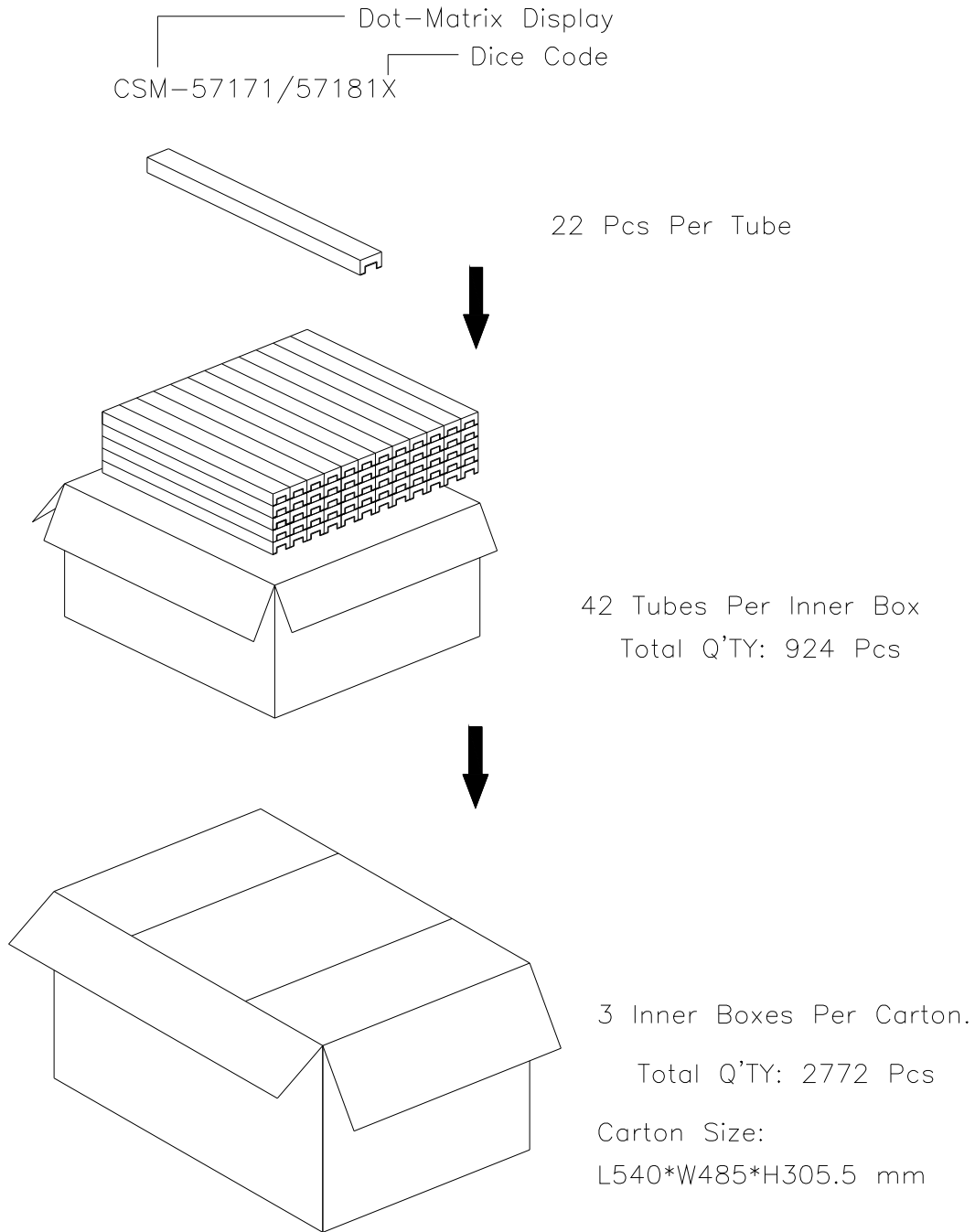

Note: The specifications are subject to change without notice. Please contact us for updated information.